

# Option Instructions

for the

## IBM Extended Graphics Adapter

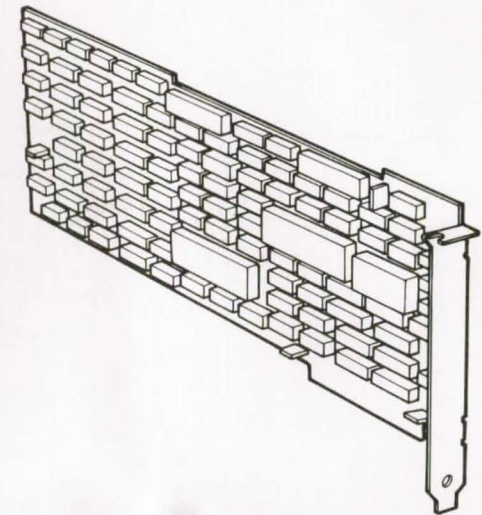
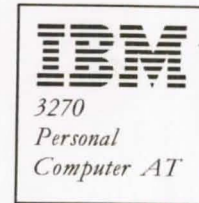

This carton should contain the:

### IBM Extended Graphics Adapter

If your card is missing or damaged, contact your local IBM representative.

S126-0078-00



S126-0078-0  
July 1985

# Contents

Introduction .....	1
Installation Requirement .....	1
Tools Required .....	2
Installation Instructions .....	3

## First Edition (July 1985)

References in this publication to IBM products, programs, or services do not imply that IBM intends to make these available in all countries in which IBM operates.

Publications are not stocked at the address given below. Requests for IBM publications may be made to your IBM representative or to the branch office serving your locality.

Address comments concerning the content of this publication to IBM Corporation, Department 52Q, Neighborhood Road, Kingston, N.Y. 12401. IBM may use or distribute whatever information or comments you supply in any way it believes appropriate without incurring any obligation to you.

# Introduction

This procedure provides step by step instructions to install the IBM Extended Graphics (XGA) Adapter card.

*Note: If this card is part of an option package, open all boxes, check the date for the installation instructions, and use the document that has the latest date.*

## Installation Requirement

The IBM Extended Graphics Adapter card can be installed in slot 2 or 3 of the IBM 3270 Personal Computer AT system unit. The system unit must have the Display Adapter card in slot 1. A rear view of the system unit showing these slots is shown below.

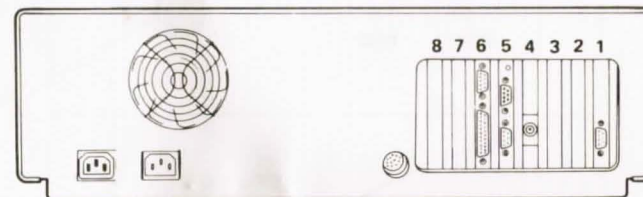

Rear View

*Note: Make sure that you have the top connectors that you need.*

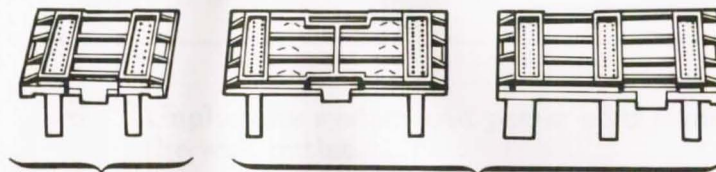

2 of these are needed for any option.

Both of these are needed if you are installing 2 adapter cards.

## Tools Required

You should have the following tools:

- A Medium-size, flat-blade screwdriver
- A 3/16-inch nutdriver (optional)
- A 1/4-inch nutdriver (optional).

## Installation Instructions

If the metal cover over the system unit has already been removed, go to Step 10; otherwise follow the steps starting here.

- 1 Set the On/Off switch on your system unit to Off.
- 2 Set the On/Off switches on all externally attached devices (e.g., printer, display) to Off.
- 3 Be sure that the Key Lock is unlocked (turn the key counterclockwise and remove the key).

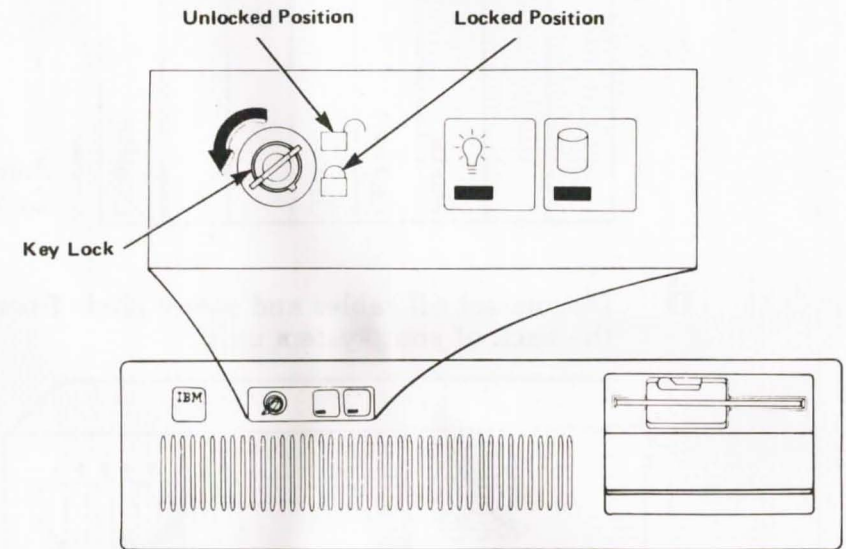

- 4 Unplug the system unit power cord from the wall outlet.

- 5 Next, you are going to remove the cables and power cords at the rear of the system unit. Before you do, follow the cables from the system unit to the unit attached to the other end of the cable (e.g. printer, keyboard) and enter the cable connections in the appropriate positions in the chart below.

*Note: YOU WILL NEED THIS INFORMATION LATER.*

The sample cables may be different from your system, so write in the cables that you have.

8	7	6	5	4	3	2	1
			Printer	Keyboard	Coax		Display

} Sample Cables

- 6 Disconnect all cables and power cords from the back of your system unit.

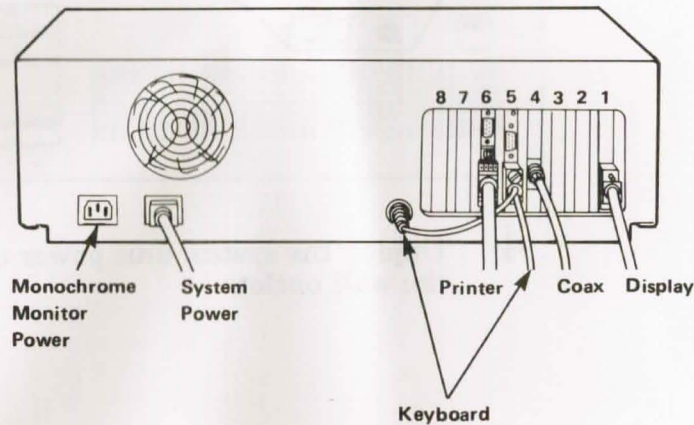

- 7 Remove the back panel from the rear of your system unit.

*Note: The back panel is attached to the system unit with plastic fastener strips.*

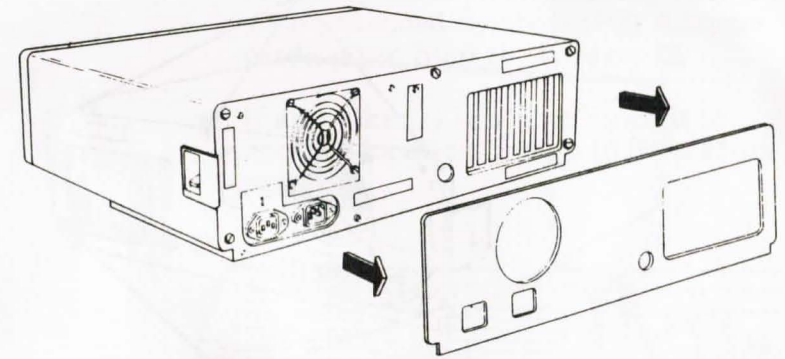

- 8 Use a flat-blade screwdriver or a 1/4-inch nutdriver to remove the five cover mounting screws, as shown in the figure below, by turning them counterclockwise. Save the screws for refastening the cover.

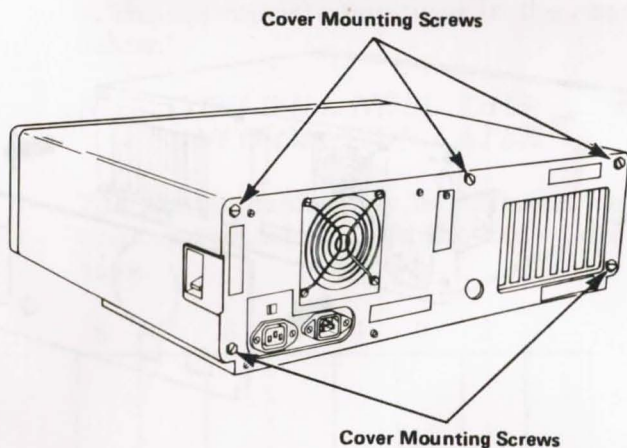

- 9 Remove the cover.

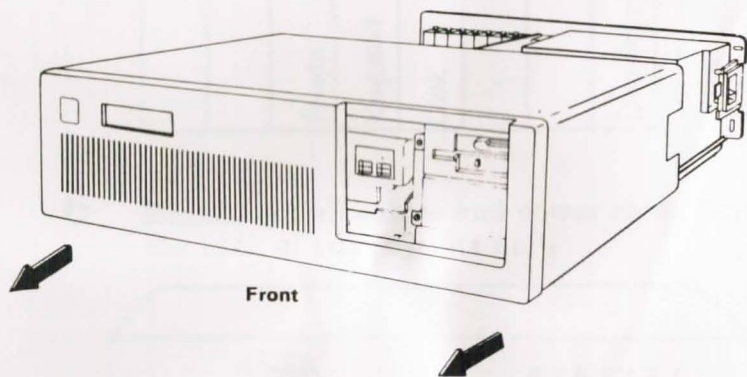

- 10 From the rear of the system unit, look to see if there is a card in slot 2.

- If slot 2 is empty, go to Step 11 on page 8.
- If the card in slot 2 has an S on the retaining bracket, (indicating that it is a Programmed Symbols (PS) Adapter card), go to Step 18 on page 12.
- If any other is in slot 2, move it to another location and go to Step 11 on page 8.

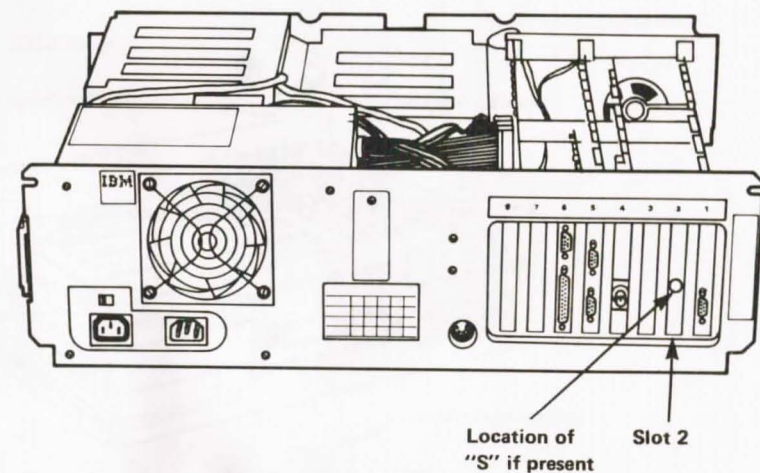

## 11 XGA Adapter Card Installation In Slot 2.

Look inside the system unit. This card must be installed in slot 2 directly adjacent to the Display Adapter card.

- 12 Use a flat-blade screwdriver or a 3/16-inch nutdriver to remove the screw that holds the expansion slot cover for slot 2 (second screw) in place by turning the screw counterclockwise. Remove the slot cover and save the screw for installing the XGA Adapter.

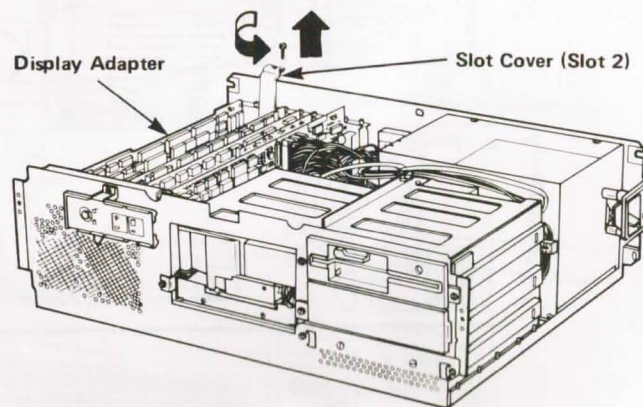

- 13 Familiarize yourself with the XGA Adapter. Then hold the XGA adapter by the top, align the card with the slot 2 guide at the front of the system unit, and press it firmly into slot 2 next to the Display Adapter.

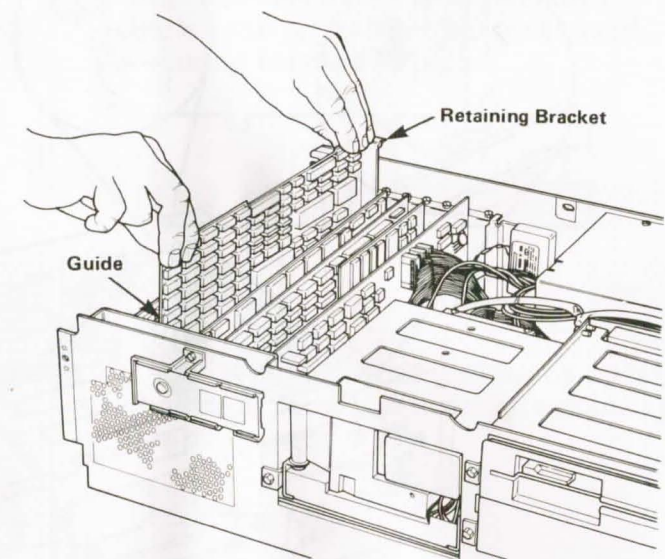
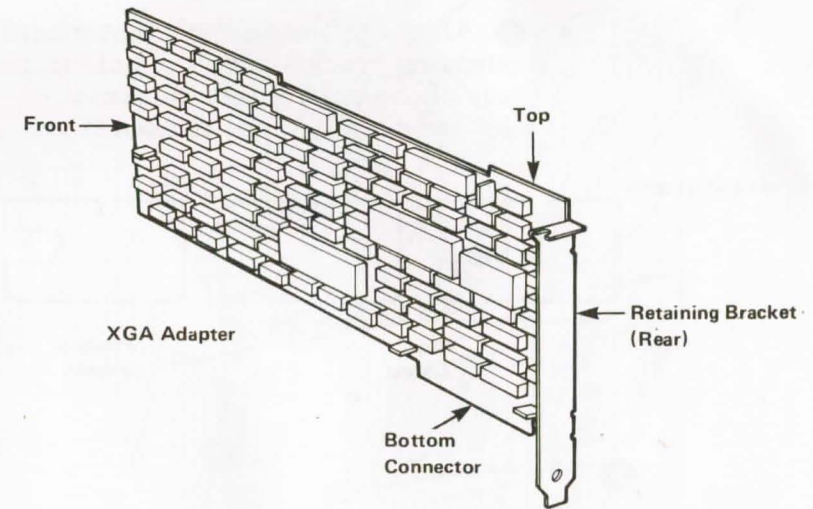

14 Begin to attach the card to the system unit.

- **A** Locate the card restraining clip that came with your new card. Press the card restraining clip into place as shown.
- **B** Align the slot in the adapter card retaining bracket with the hole in the rear of the unit. Start the screw clockwise, but do not tighten it yet.

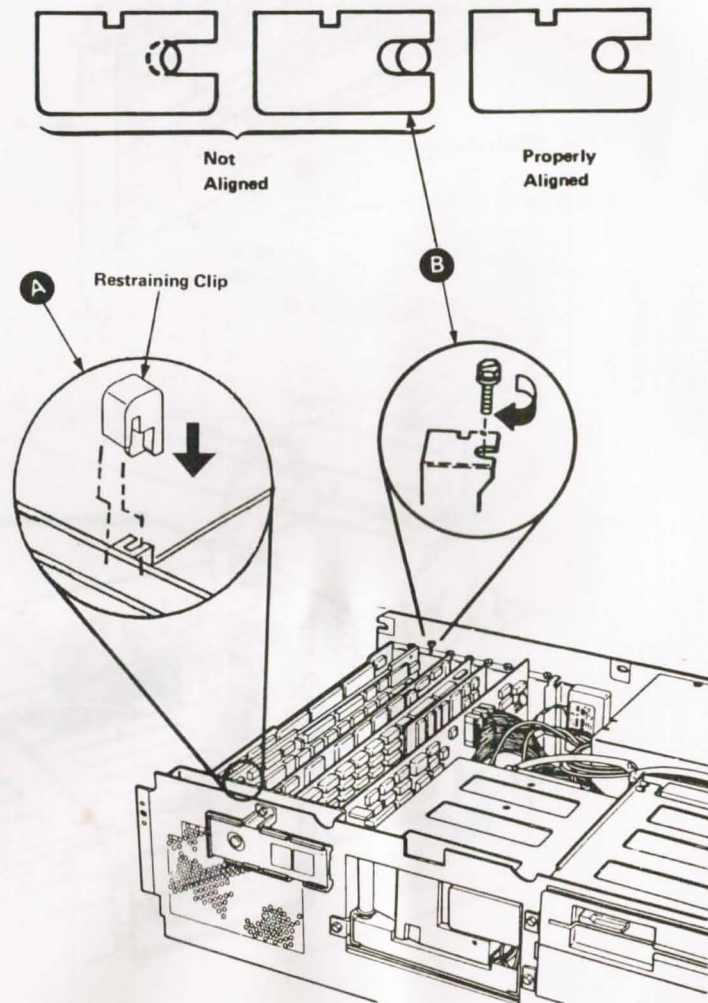

15 Install the two top card connectors between the XGA Adapter and the Display Adapter as shown. Press the connectors into place firmly.

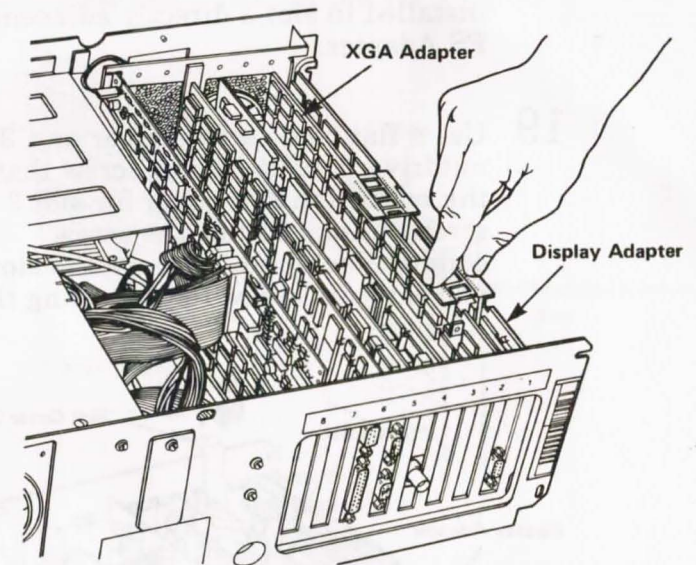

16 Align the slot again as shown below. Now tighten the screw that holds the card retaining bracket in place.

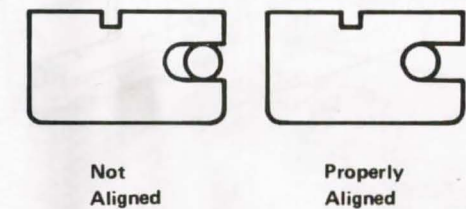

17 If you have any other options to install do so now. If there are no more options, go to Step 25 on page 17.



## 18 XGA Adapter Card Installation In Slot 3.

Look inside your unit. The card must be installed in slot 3 directly adjacent to the PS Adapter.

- 19 Use a flat-blade screwdriver or a 3/16-inch nutdriver to remove the screw that holds the expansion slot cover for slot 3 (third screw) in place; turn the screw counterclockwise. Remove the slot cover and save the screw for installing the XGA Adapter.

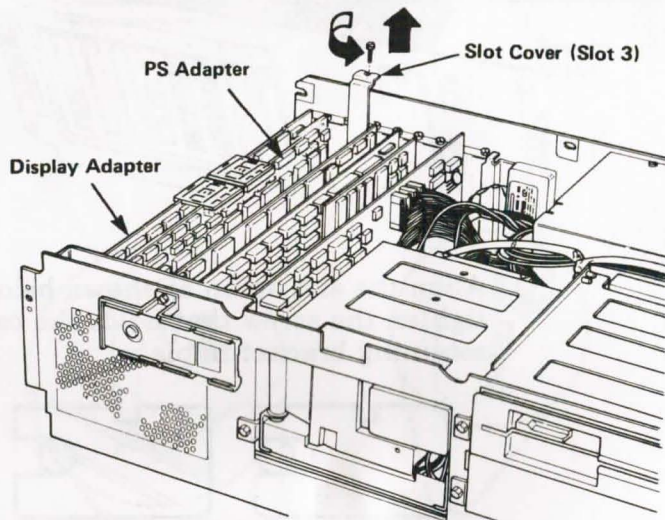

- 20 Familiarize yourself with the XGA Adapter. Then hold the XGA adapter by the top, align the card with the slot 3 guide at the front of the system unit, and press it firmly into slot 3 next to the PS Adapter.

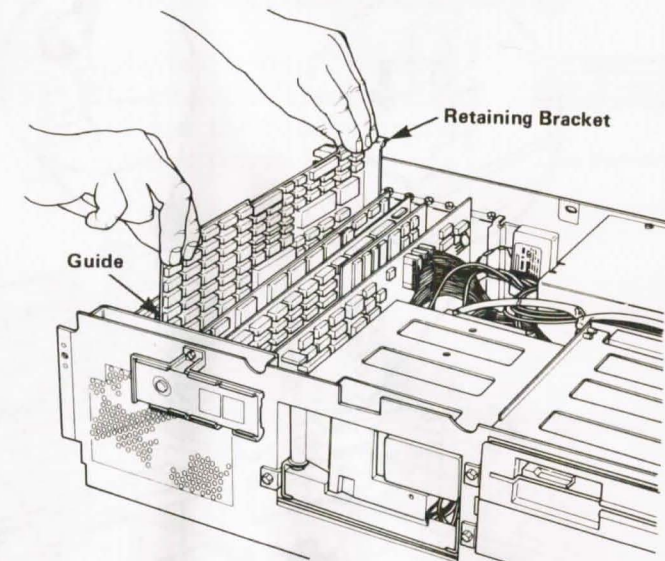
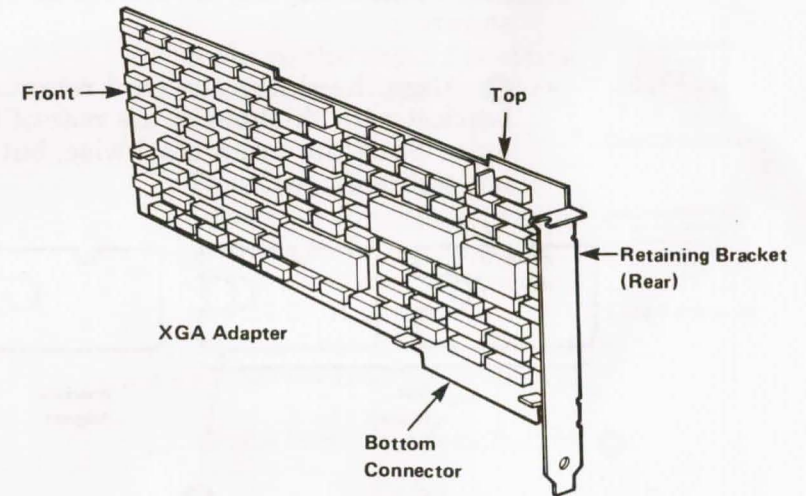

## 21 Begin to attach the card to the system unit.

- **A** Locate the card restraining clip that came with your new card. Press the card restraining clip into place as shown.
- **B** Align the slot in the card retaining bracket with the hole in the rear of the unit. Start the screw clockwise, but do not tighten it yet.

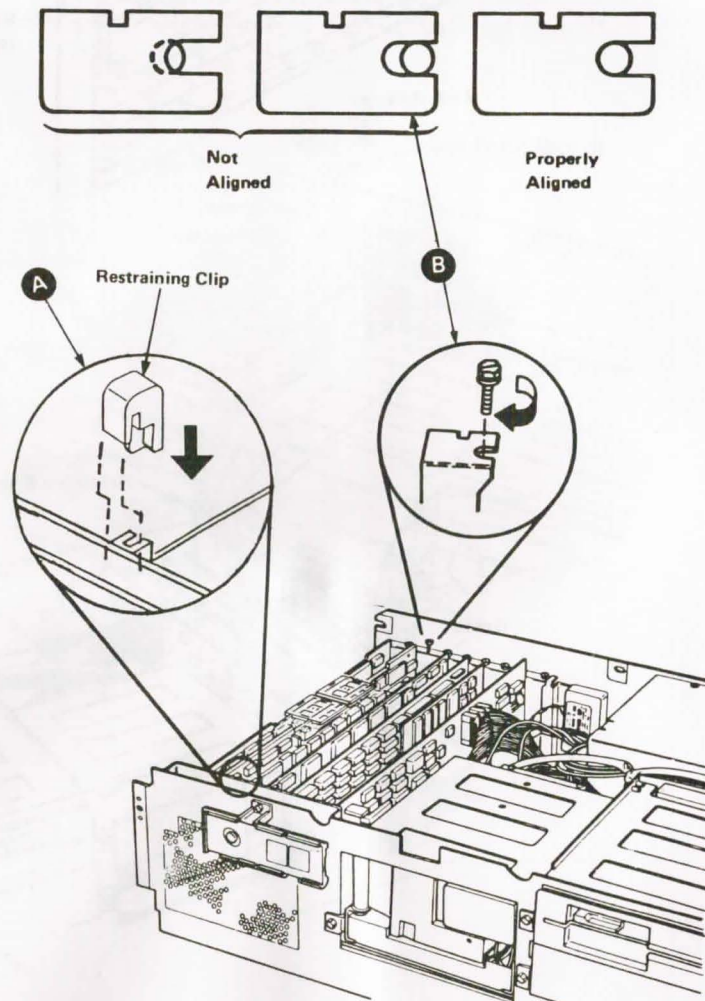

## 22 Install three top card connectors between the XGA Adapter, the PS Adapter, and the Display Adapter as follows:

- a. At the location identified by **A**:

Remove the short 2-position connector; it is no longer needed.



Then install a long 3-position connector (white shroud) with the thick leg of the connector at the card in slot 3. It cannot be installed otherwise. Press the connector into place firmly.

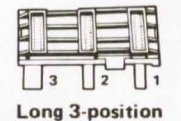

- b. At the location identified by **B**:

Leave the short 2-position connector in place.

- c. At the location identified by **C**:

Install a long 2-position connector (black shroud). Press the connector into place firmly.

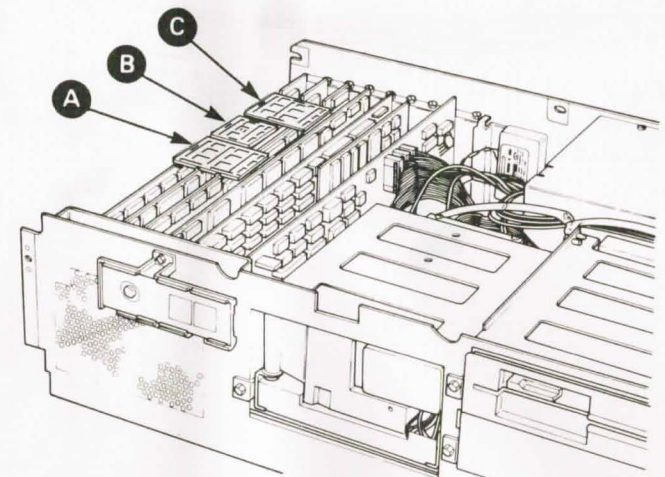
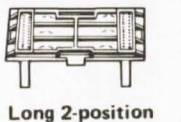

- 23** Align the slot again as shown below. Now tighten the screw that holds the card retaining bracket in place.

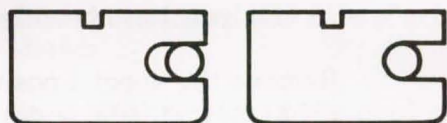

Not  
Aligned

Properly  
Aligned

- 24** If you have any other options to install, do so now. If there are no more options, go to Step 25 on page 17.

## 25 Putting on the cover.

Push the cables down and out of the way. They should be no higher than the power supply.

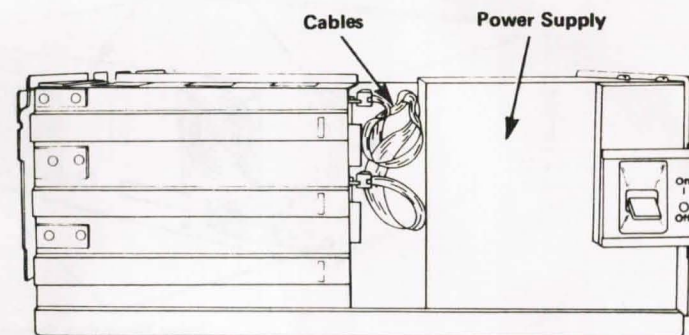

Side View

## 26 Install the system unit cover.

- Make sure that the cover is under the rail on the frame.
- Lift the cover up against the rail and slide it onto the system unit.

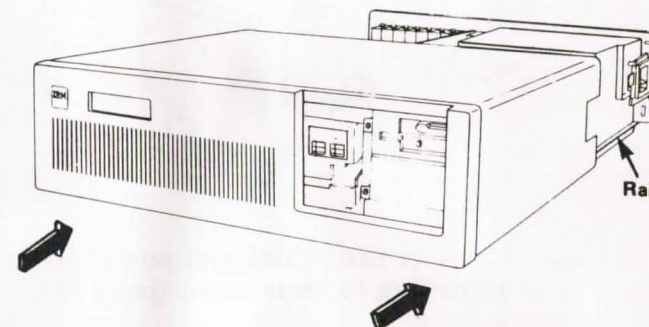

- 27 Install the five cover mounting screws.

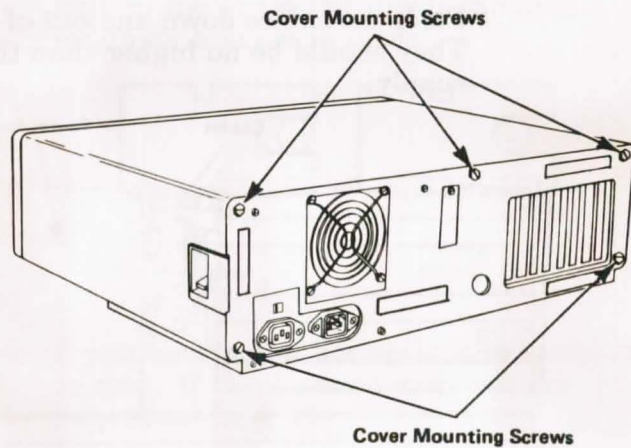

- 28 Position the back panel on the system unit and press it into place. The fastener strips hold the back panel in place.

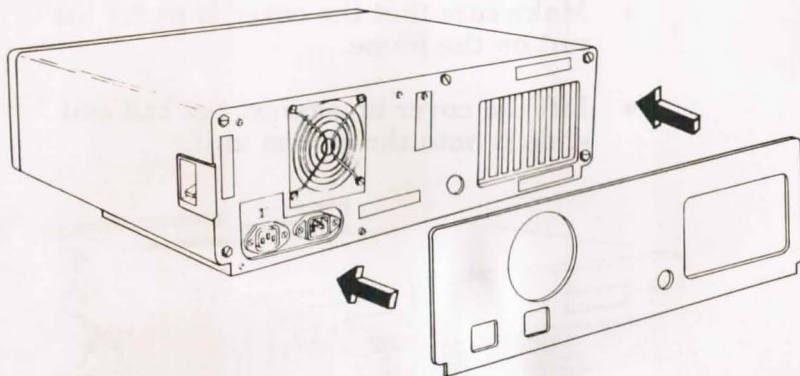

- 29 Connect the cables and power cords according to your notes (page 3).
- 30 Installation is complete. Go to "Power-On Self-Test" in Chapter 2 of Book 1 of your *Guide to Operations* manual to run tests to verify correct installation of cards and cables.